



Beyond the Digital Thread

AI, People, and the Future of Manufacturing Execution

Garth Coleman, CEO

40+ years experience

Founded 1986

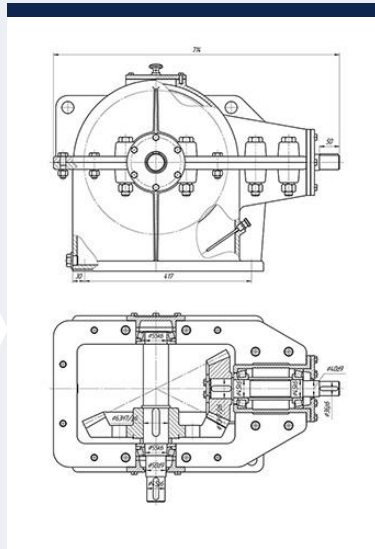

Graphics

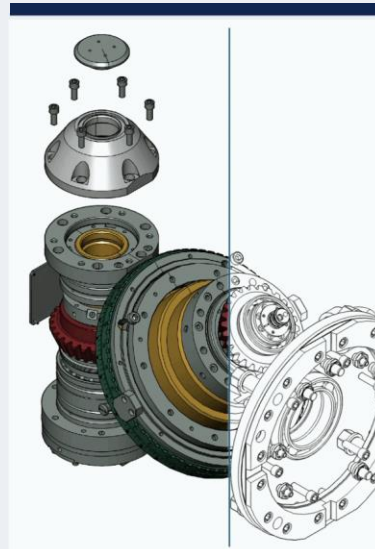

3D models

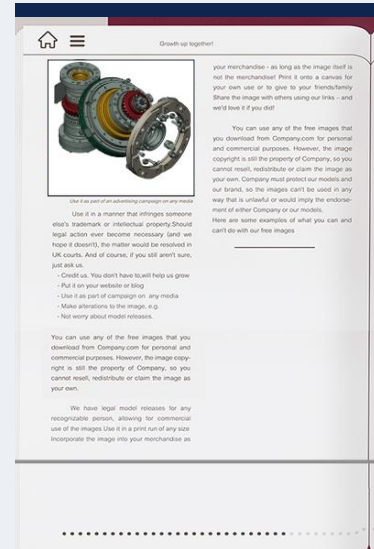

Static



Interactive



AI

100K+ users

Who Are We?

Automotive



Aerospace
and Defense



Oil
and Gas



Ship Building
and Maritime



Transportation

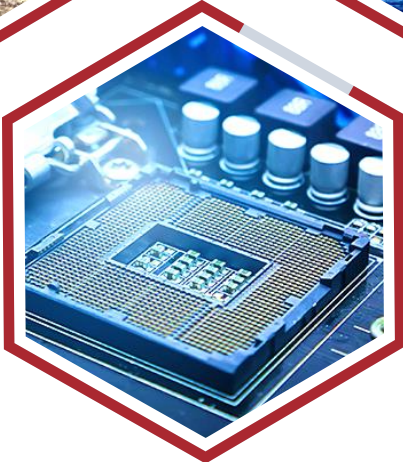

Consumer
Electronics



Energy
and Utilities



Life Sciences and
Medical Devices

Clients



Partnerships



The Hurdles to Effective Knowledge Transfer



Complexity
Product process

Expertise transfer



Expert worker supply



Worker demand

Interactive instruction

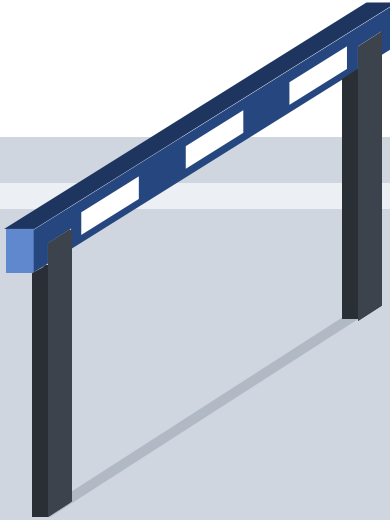
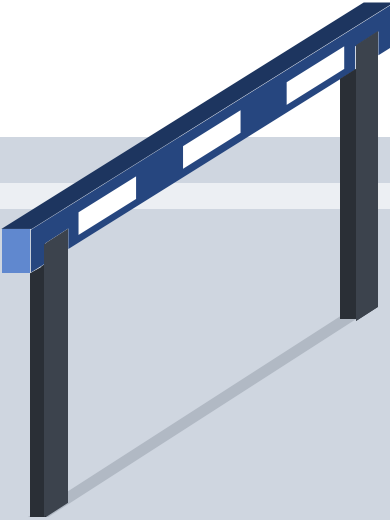
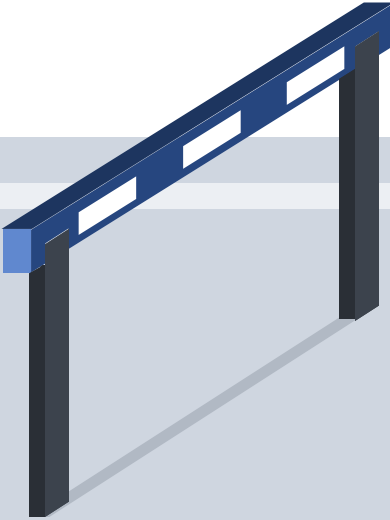
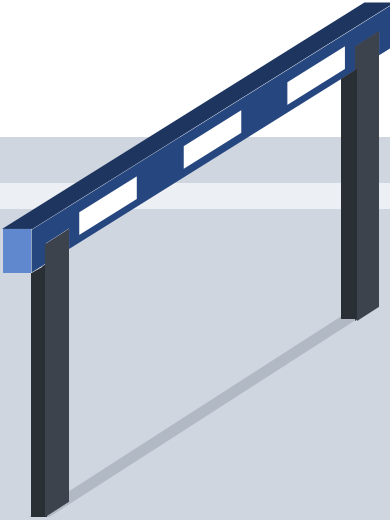
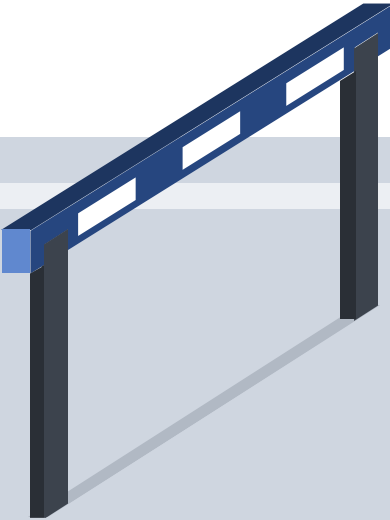

Removing the Hurdles to Knowledge Transfer

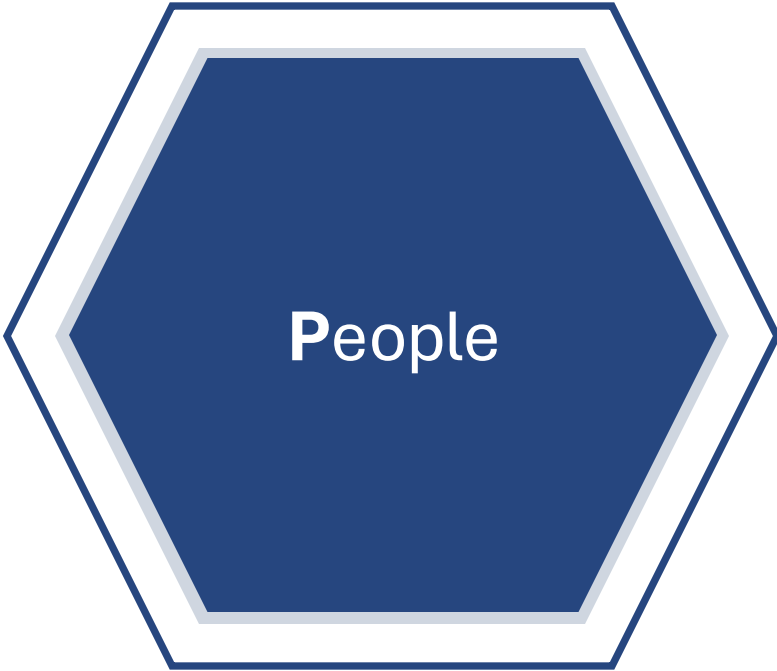

Removing the Hurdles to Knowledge Transfer

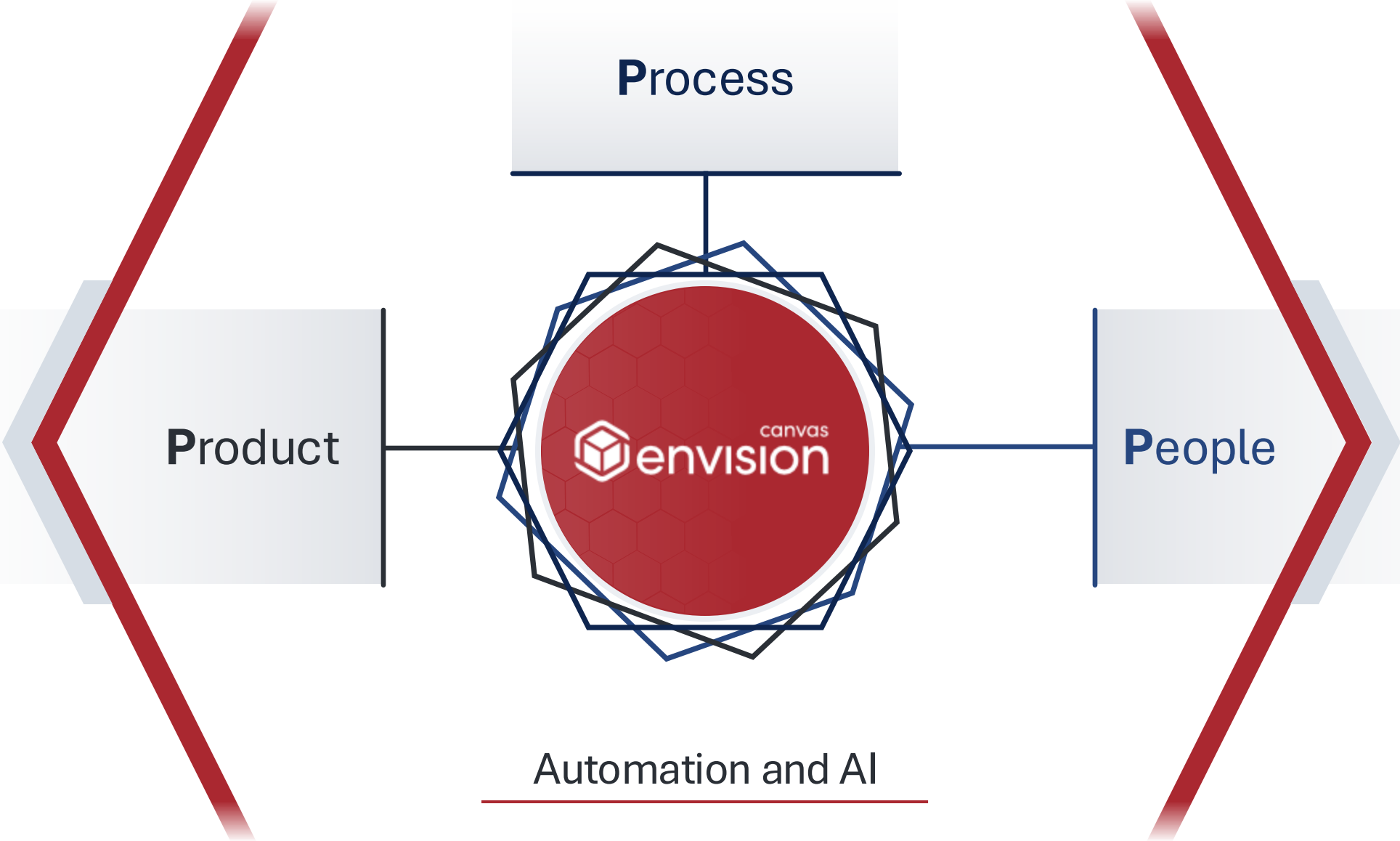

Bridging the Knowledge Gap



Time



Updates



Disconnected



Experts

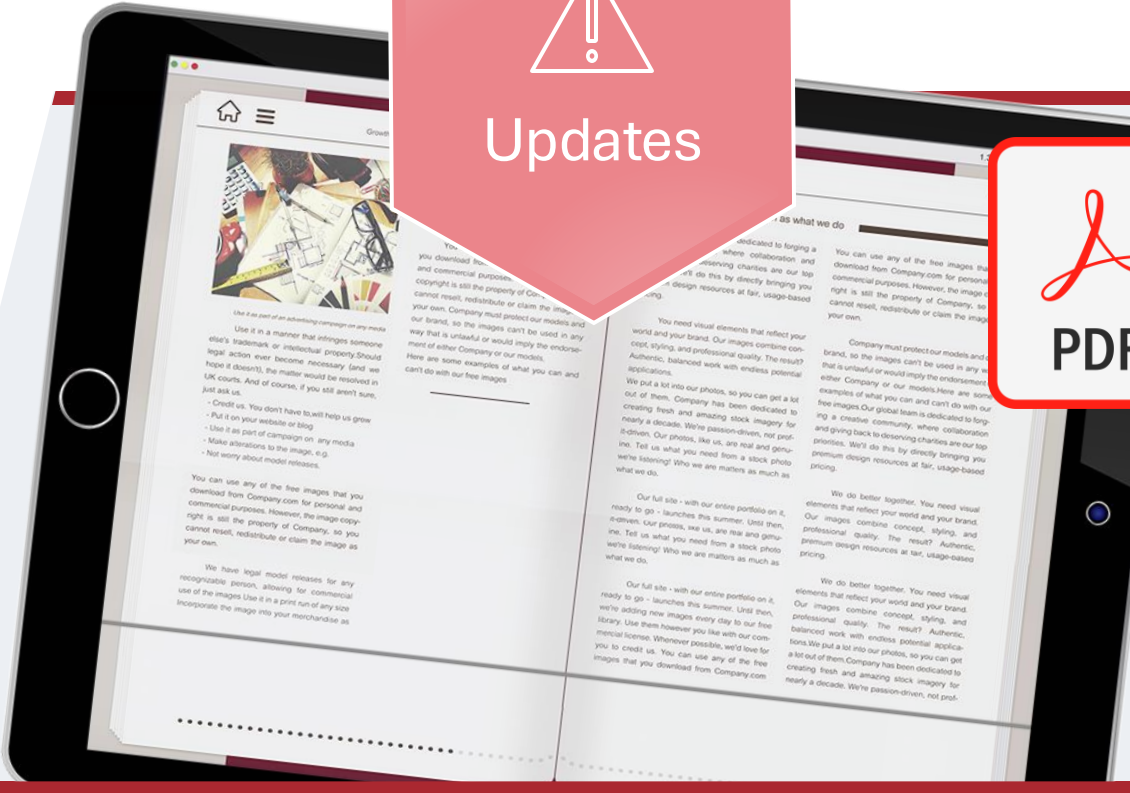

Page based instructions



Frontline workers

Bridging the Knowledge Gap

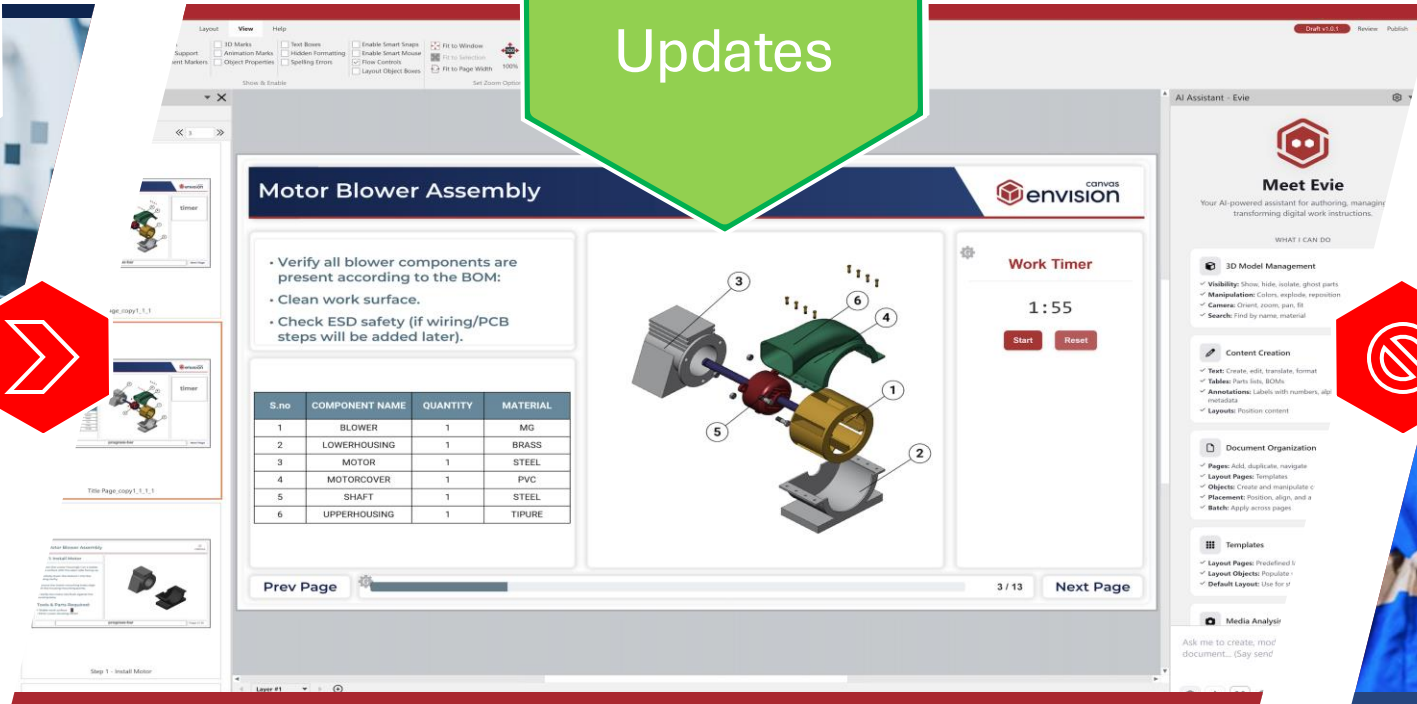

Motor Blower Assembly

- Verify all blower components are present according to the BOM:
- Clean work surface.
- Check ESD safety (if wiring/PCB steps will be added later).

S.no	COMPONENT NAME	QUANTITY	MATERIAL
1	BLOWER	1	MG
2	LOWERHOUSING	1	BRASS
3	MOTOR	1	STEEL
4	MOTORCOVER	1	PVC
5	SHAFT	1	STEEL
6	UPPERHOUSING	1	TIPURE

Work Timer: 1:55

Prev Page 3 / 13 Next Page



Experts

Visual Execution Platform

Frontline Workers

Canvas Envision – The Visual Execution Platform

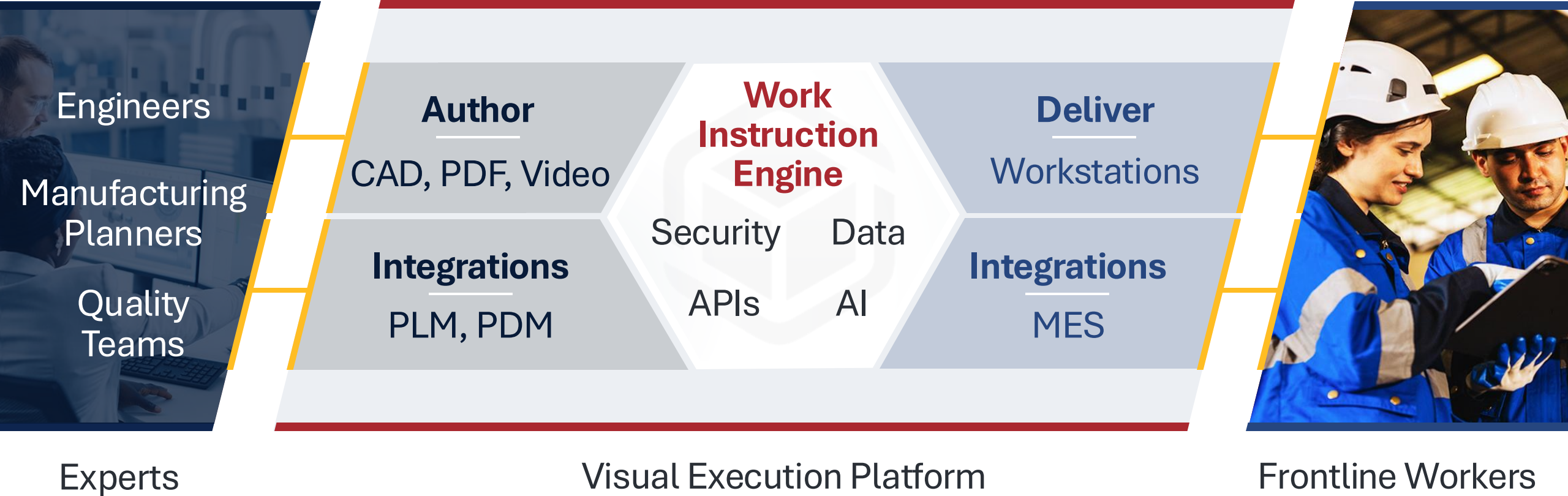



Meet Evie

Canvas Envision's AI. Purpose-built for manufacturing.



Intelligent Authoring

Suggests content, structures steps, drafts instructions from engineering data. Batch operations across entire documents in seconds.



3D Model Understanding

Reads full assembly hierarchies, classifies parts, recommends assembly order, and creates exploded views and labels.



Legacy Content Conversion

PDF to WI, Video to WI, 3D to Assembly. Transform existing content into structured, interactive instructions.



Knowledge Library

Your company's standards, terminology, and templates built into every prompt. Consistency enforced at creation time.



AI in Manufacturing: Two Modes

AI that helps experts work faster, not AI that replaces them.



AI Assistant

Interactive. You prompt, AI responds.

- Author directs; AI executes
- Batch operations across documents
- Complex 3D manipulation via chat
- Feature guidance and help
- Free-form content creation



AI Agents

Goal-directed. Click and the system takes over.

- System analyzes, plans, and executes
- Multi-model orchestration
- Predictable, repeatable results
- Built-in quality checks
- Custom agents for your processes

Evie AI Agents

No prompting required. Select an agent. Upload your source. Review the output.



PDF to Work Instruction

Upload a legacy PDF manual. Evie analyzes structure, extracts text and figures, and creates step-by-step instructions.

6 hrs → 10 min

20-page PDF conversion



Video to Work Instruction

Upload a training video. Evie segments it into logical steps with embedded clips and written instructions from narration.

3 hrs → 5 min

10-min video conversion



3D Assembly Instruction

Select a 3D assembly. Evie classifies parts, recommends assembly order, and generates illustrated step-by-step instructions.

2 days → 15 min

50-part assembly

Evie Workflow Agent – Video to Instruction to 3D WI

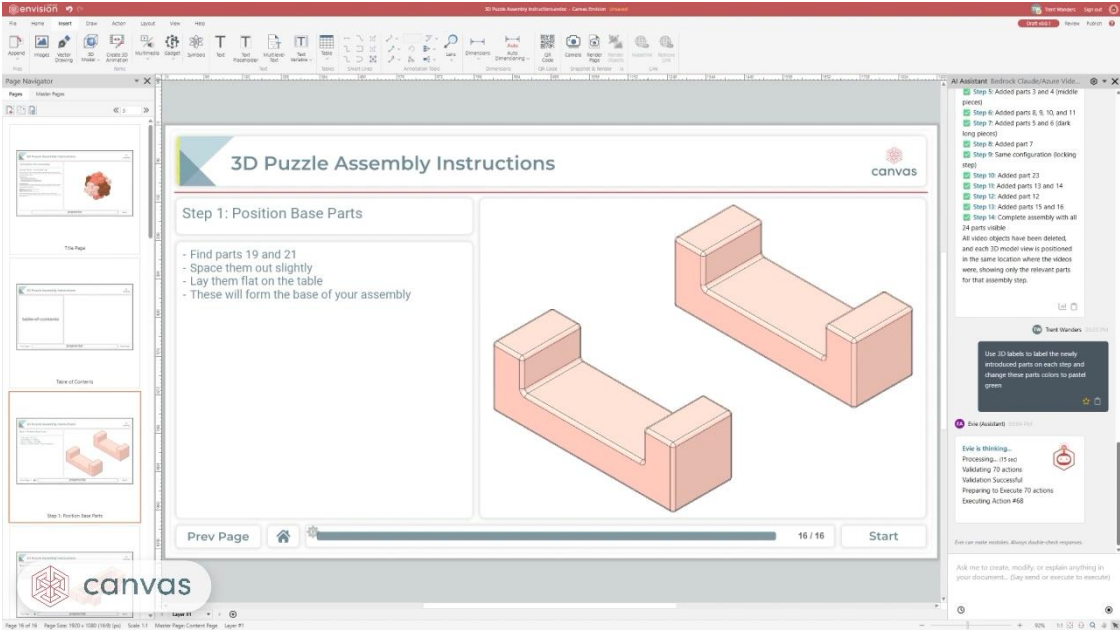
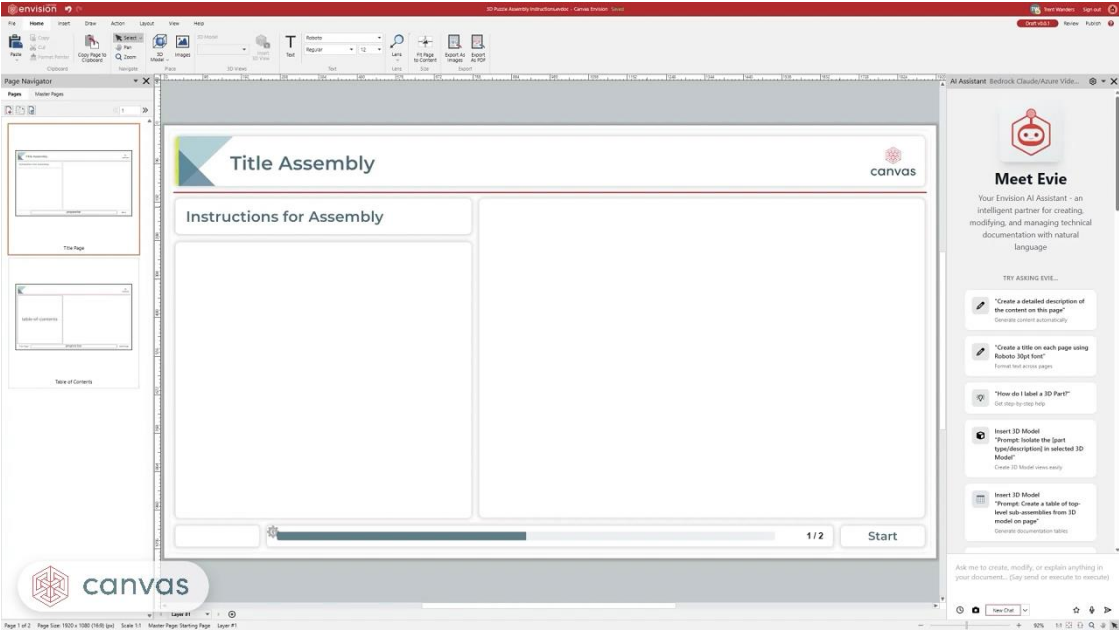

AI Agent: Video to Work Instruction

AI Agent: Replace Video with 3D

**Execute
Visually**

**Capture
Knowledge**

**Connect
Systems**

**Accelerate
Adoption**

Unlock ROI

Why



canvas
envision

?